

Maximum Power Point Tracking Technique For PV System By Using Golden Section Search Method

Sonvir Singh¹

¹*Department of Computer Science & Engineering, Visvesvaraya National Institute of Technology, Nagpur, India*

E-mail: sonvirsingh036@gmail.com

Abstract: Importance of Non-Conventional Source of Energy (NCSE) is upsurging day by day to tackle the increased load, energy consumption, and environmental pollution related problems. Out of Non-Conventional Source of Energy (NCSE), Solar Energy, mainly Solar Photovoltaic (SPV) energy, is one of the most promising Renewable Source of Energy (RES) because of pollution-free, no rotating part, an abundance of solar energy, low-cost energy, and high efficiency. The main thing is how to extract maximum power from the Solar PV panel. Power extract from the PV system depends upon the solar radiation (isolation), ambient temperature and terminal voltage. Regulation of terminal voltage is required to extract the maximum power at the operating point. The technique of extracting maximum power by changing its terminal voltage by the various methods is called as MPPT. This paper takes up the problem of finding the MPPT power point under changing environmental conditions, developing efficient MMPT and changing the operating point of the system very fast according to the environmental condition. In this paper, a new MPPT technique is developed for tracking maximum power point which is efficient to existing techniques with the help of the Golden Section Search Optimization Method. This paper is intended to serve an efficient method and reliable to find the maximum power point at which maximum power is extracted from the PV system.

Keywords: Maximum power point tracking (MPPT) techniques, Non-Conventional Source of Energy (NCSE), solar photovoltaic (SPV) Energy, Photovoltaic (PV) system

1. INTRODUCTION

To Extract Maximum Power from the Photovoltaic (PV) systems under different environmental conditions, the Maximum Power Point Techniques are used. This principle is generally used for those sources which have variable power outcome, for example, optical power transmission, thermophotovoltaic etc. PV system has a different configuration in respect to their relationship to the inverter, grid system, batteries or electrical load. But the ultimate destination is that to transfer more power from the PV cell, which depends upon the three factors-falling of sunlight on the solar panels, the temperature of the PV panel and electrical load characteristic. Temperature remains constant by using heat sink material at the backside of the panel. As the load characteristic, when sunlight intensity changes the maximum power transfer changes accordingly then the load characteristic that gives maximum transfer efficiency also changes.

Maximum Power Point Technique (MPPT) is a technique, which includes the electronics controller used for the extracting maximum available power from the PV panel under various weather conditions. The maximum power extraction from the PV panel varies with Solar Radiation, Ambient Temperature, Solar Cell Temperature. MMPT helps in finding the point at which power transfer from the panel to load is maximum. PV cells have a complicated relationship between temperature and resistance that produce Non-linear characteristic. Which can be analyzed based on the I-V plot. The main function of MPPT is to change the output

voltage of the PV cells and provide a proper load to obtain maximum power for any given condition [1].

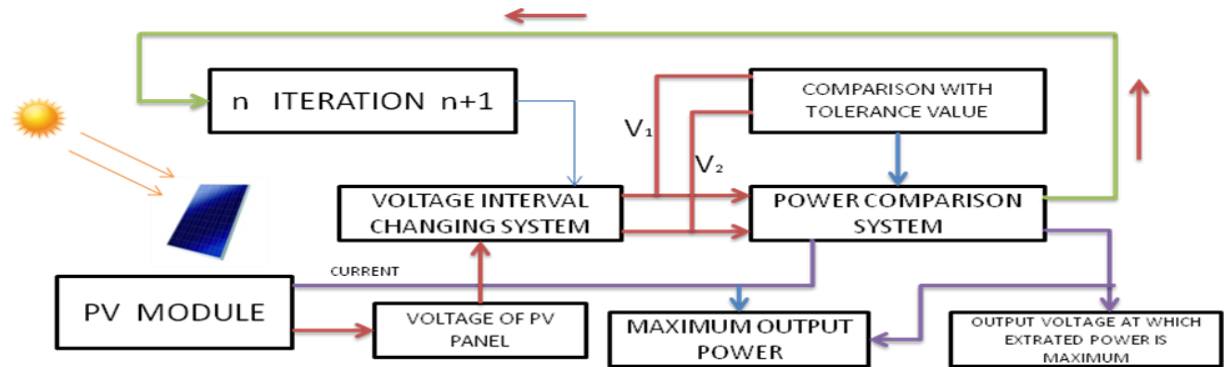

Fig. 1 Block diagram of the proposed model.

An MPPT is used for adjusting the voltage level according to the varying output of PV panel for extracting the maximum power for the PV and transferring that power to the variable or fixed the load [2] [3]. A converter and controlling unit as an interface between the load and PV module. By changing the load voltage, the load impedance seen by the source is varied and matched at the point of peak power with the source so as to transfer the maximum power[3]. Therefore MPPT technique is needed to operate the PV system at the maximum power point. Many MPPT techniques have been proposed in the literature, examples P&O methods, Incremental conductance(IC) methods etc [4] [5].

The main advantage of the P&O MPPT algorithm is its low cost and easy implementation but, it may fail to track the maximum operating point under varying weather conditions [6]. The step size of the duty cycle change required at the initial stage and final stage to find the maximum power point [7]. Value of step size of the duty cycle should be taken large for points far away from the maximum power point and small for points near the MPPT [8]. Different methods of finding the maximum power point have different outcomes. Some are better in finding the maximum power point at varying environmental condition and some are fast in the respect of time, accuracy and efficiency [9,10].

In this research paper, the system performance is optimized by Golden Section Search Method. By changing the interval or selection of section without using a Buck-boost converter, the source impedance can be matched to adjust the load impedance to improve the efficiency of the system. The proposed model is shown in Fig. 1.

2. PHOTOVOLTAIC SYSTEM.

The system which converts solar energy into electrical energy is called a photovoltaic (PV) system. The basic or smallest unit of PV system is PV cell. These cells are arranged in parallel, series or series-parallel as per requirement. The voltage and currently available at the terminal of PV system, it is directly fed to small loads like lighting, DC motors or connected to the distribution grid by using energy conversion devices [2]. Main parts of PV system are PV module, charger, battery, inverter, and load.

2.1. Equivalent Model

A photovoltaic cell is a device used to convert solar radiation into electrical energy. The equivalent circuit diagram of the photovoltaic cell shown in Fig. 2 PV cell is a current source, it is produced by breaking of bonds and generation of electron and hole which causes the flow of current in the cell. The equivalent circuit consists current source, diode, shunt resistance, series resistance and load. Shunt resistance represents the electron-hole combination before its

reach to load. The generation currently in the PV panel depends upon the physical and chemical properties of the material, the age of the solar cell, irradiation per unit area and temperature of the cell, environmental conditions, spectral characteristics of sunlight, dirt, and shadow and so on [11,12].

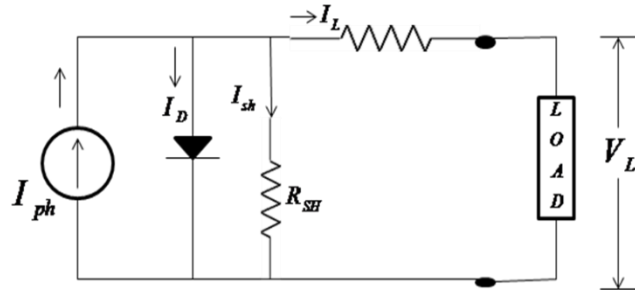

Fig. 2 Equivalent Single PV cell Model

The diode current is given by the equation

$$I_D = I_O \left[e^{\frac{q(V_L - I_L R_L)}{nKT}} - 1 \right] \tag{1}$$

The load current which flows in the load is a difference of the photocurrent, diode current and shunt resistance current is given by.

$$I_L = I_{ph} - I_D - I_{sh} \tag{2}$$

Shunt resistance (R_{sh}) represent the electron-hole combination before it reaches to load (for simplifying ignore R_{sh}), I_{sh} current becomes zero.

$$I_L = I_{ph} - I_O \left[e^{\frac{q(V_L - I_L R_L)}{nKT}} - 1 \right] \tag{3}$$

Where,

- I_L is the load current or cell current (A).
- n is the ideality factor.
- q is the charge of the electron (coulomb).
- K is the Boltzmann's constant (J/K).
- T is the temperature of the cell.
- I_{ph} is the photocurrent (A).
- R_s, R_{sh} are series and shunt resistance of the cell (ohms).
- V_L is the cell output voltage (V).

After solving Equation No.-3, the load voltage is

$$V_L = \frac{nKT}{q} \ln \left(\frac{I_{ph} - I_L}{I_O} + 1 \right) - I_L R_s \tag{4}$$

In the case, open circuit, $I_L=0$ than the corresponding voltage is open circuit voltage (V_{OC}).

$$V_{OC} = \frac{nKT}{q} \ln \left(\frac{I_{ph}}{I_O} + 1 \right) \tag{5}$$

This is the order of 10^{-5} . It should be noted that V_{OC} will not reduce as much as I_{ph} change. In the case of short circuit, $V_L=0$ and impedance are low tags corresponding current is short circuit current which can be approximated as:

$$I_{SC} = qG(L_n + L_p) \quad (6)$$

Where G is the rate of generation of electrons and holes, L_n and L_p are the diffusion length of electrons and holes respectively. Above equation is not true for the most of cell because of several assumptions. The above equation shows that the short circuit current depends upon the generation rate and diffusion rate.

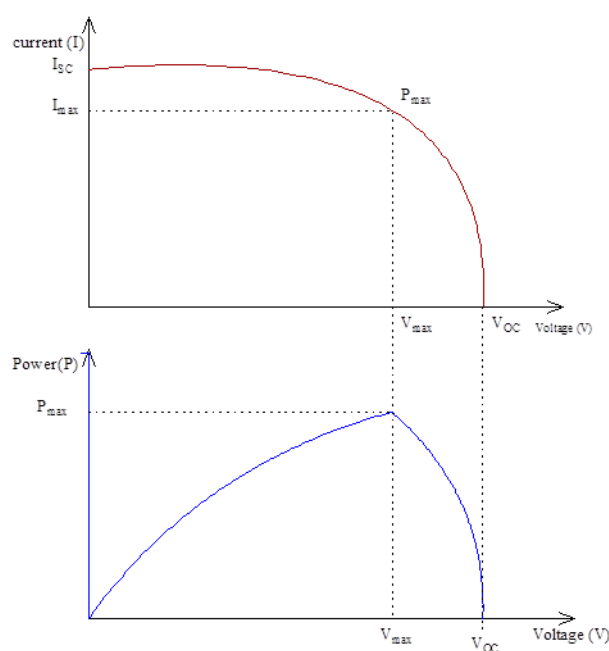

Fig.3 I-V and P-V characteristics of PV Panel

The current-voltage characteristic curve of a PV cell for a certain irradiance at fixed cell temperature is shown in the Fig No.-3. The current of PV cell depends upon the external applied voltage and amount of sunlight sticking the surface of the cell. The power Vs voltage curve showed in Fig No.-3. Here P is the power extracted from the PV cells. The curve mainly depends upon current insolation and temperature when insolation increases the power output of PV panel increases whereas when the temperature of the cell increases the power output of PV panel is decreases [13]. Constant power generated by the PV panel may also be used to provide the energy to the main grid and micro-grid. Energy distribution Priority is decided by the priority factor, load and prize forecasting [14].

2.2. Temperature effect.

In this paper, consider only two factor falling sunlight on the solar panel and electrical load characteristics. Make temperature as a constant throughout the process by using temperature controller like heat sink material system [15]. Heat sink material put in between glass cover of solar panel and cells. Increased in temperature of solar panel decreased the output of the solar panel. To improve the efficiency of the solar panel, consider the temperature as constant in this paper with the help temperature control system. For controlling the temperature of the solar panel the temperature sensor is used to detect the temperature and heat sink material sink the heat if the temperature is more than the pre-set value and this heat is transfer outside by

the help of small cooling fans. So that temperature remains constant throughout the day during processing. Systematic Diagram is shown in Figure No.-4.

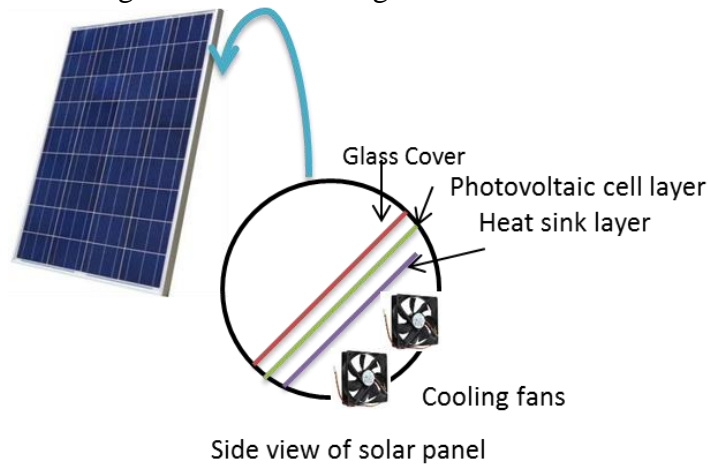

Fig.4 Side View of Solar Panel

3. GOLDEN SECTION SEARCH TECHNIQUE.

The Golden Search technique is a technique to find out the minimum and maximum (extremum) of strictly increasing and decreasing curve for particular interval or say for unimodal function by successively narrowing the range of values inside in which extremum point know to exist. Here, this technique is used to find out the Maximum power point in the PV curve [16].

3.1 Unimodal function.

A function $f(x)$ is unimodal on $[a,b]$ interval if for some point x^* on $[a,b]$, $f(x)$ is strictly increasing on $[a,x^*]$ and strictly decreasing on $[x^*,b]$. concave and convex shape type functions are unimodal. Unimodal type function make the search easier to find maximum point in the given interval. Start with an interval of uncertainty (the interval in which maximum point must lie) equal to $[a,b]$, whose length is difference of end point of interval i.e $b-a$.

Consider two points in the interval $[a,b]$ and evaluate the function at these points

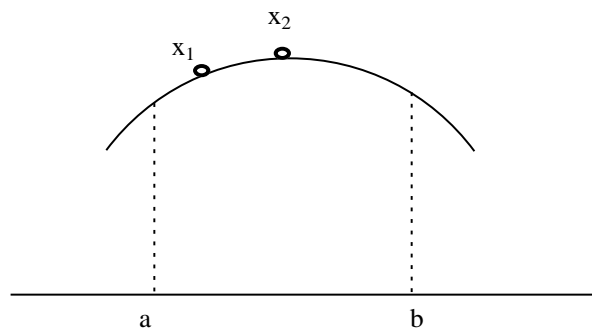

If $f(x_1) < f(x_2)$, function is increasing in the range $[x_1,x_2]$. Therefore, the function value must be greater than $f(x_1)$. Since the function is unimodal, then maximum cannot be lying in the range of $(a, x_1]$. Thus concluding that the maximum is in the range of $(x_1, b]$.

If $f(x_1) > f(x_2)$, since function is unimodal, the function's maximum must be greater than x_2 .therefore the maximum must lie in the range $[a, x_2]$.If $f(x_1) > f(x_2)$, then the maximum must lie in the range of (x_1,x_2) . since the points, x_1 and x_2 have to be on either side of the maximum.

According to Fibonacci Method

$$F_n = F_{n-1} + F_{n-2} \tag{7}$$

Dividing the above equation by F_{n-1} .

$$\frac{F_n}{F_{n-1}} = 1 + \frac{F_{n-2}}{F_{n-1}} \tag{8}$$

Golden ratio (γ)

$$\nu = \lim_{n \rightarrow \infty} \frac{F_n}{F_{n-1}} = \lim_{n \rightarrow \infty} \frac{F_{n-1}}{F_{n-2}} = \lim_{n \rightarrow \infty} \frac{F_{n-j}}{F_{n-(j+1)}} \tag{9}$$

Take limit on both side of equation (2) and replace with the golden ratio.

$$\nu = 1 + \frac{1}{\nu}, \nu^2 - \nu - 1 = 0 \tag{10}$$

After solving the equation No.-4

$$\nu = \frac{1 \pm \sqrt{5}}{2}, \text{ consider the only positive root of } \nu$$

$\nu = 1.618$ (Golden Ratio Value) [17].

$$r = \frac{1}{\nu} = 0.618$$

r is Conjugate Root or Conjugate Golden Ratio.

3.2 Iterative Process for finding maxima.

Step-1:

Given initial of uncertainty = $[a, b]$, whose length is $(b-a)$, stopping tolerance (ϵ).

Step-2:

$$L_1^* = r(b-a),$$

$$L_1^* = \lim_{n \rightarrow \infty} \frac{F_{n-1}}{F_n} L_0 = \lim_{n \rightarrow \infty} \frac{F_{n-2}}{F_{n-1}} * \frac{F_{n-1}}{F_n} L_0$$

Now, $x_1 = a + L_1^*$ and $x_2 = b - L_1^*$

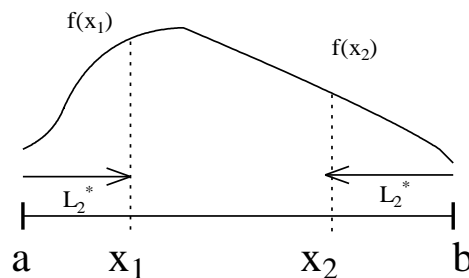

Points on x-axis are x_1 and x_2 , their corresponding values of function $f(x_1)$ and $f(x_2)$ respectively

If $f(x_1) > f(x_2)$, the interval of uncertainty is $[a, b]$ but now the new interval become $[a, x_2)$ $L_1=r(b-a)$, check the condition, if $L_1 < \epsilon$ than stop the iteration process and maxima must lie in $[a, x_2)$. if not, then goes to next step

Step-3: Generate x_3 .

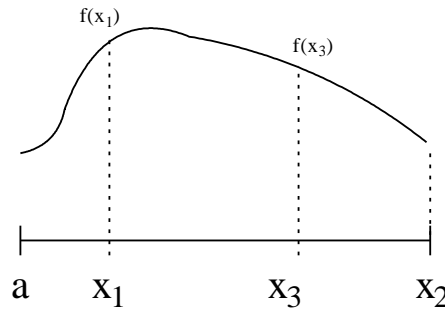

Now, $x_2=b$

$$L_2^* = r(x_2 - a)$$

Now, $x_3= x_2- L_2^*$ and $x_1= a+ L_2^*$

Points on x-axis are x_1 and x_3 , their corresponding values of function $f(x_1)$ and $f(x_3)$ respectively

If $f(x_1) > f(x_3)$, Discard $(x_3, x_2]$ and new interval become $[a, x_3]$.

$L_2=r^2 (b-a)$, check the condition, if $L_2 < \epsilon$ than stop the iteration process and maxima must lie in $[a, x_3]$. if not, then goes to the next step

This process is stopped when the distance between the outer points is smaller than stopping tolerance. If $L_k < \epsilon$ maxima are found, stop the iteration.

4. THE GOLDEN SEARCH METHOD.

Consider the voltage range in which the possibility of finding the maximum power point is (v, V) . Normally in the case of PV curve v equal to zero and V is open circuit voltage. After each iteration, the voltage range is changing accordingly the range length also reducing after execution of each iteration. Searching will stop when range length less than or equal to the tolerance.

Length of uncertainty interval.

$$L_k = r^k (v_o - V_o) \tag{11}$$

Here k represents no. of iteration to find out the voltage at which power transfer is more. Solve above equation by taking natural logarithmic both side to find the value of k

$$k = \frac{\ln(L_k / (v_o - V_o))}{\ln r} \tag{12}$$

Algorithm: GOLDEN SECTION SEARCH ALGORITHM

- 1: Define the interval of uncertainty as $(v_o - V_o) = (v, V)$
- 2: Calculate $V_{1k} = V_k - r(V_k - v_k)$
- 3: Calculate $V_{2k} = v_k + r(V_k - v_k)$

- 4: if $(P(V_{1k}) < P(V_{2k}))$ then.
- 5: P^* must be in (V_{1k}, V_k)
- 6: $v_{k+1} = V_{1k}$
- 7: $V_{k+1} = V_k$
- 8: else
- 9: P^* must be in (v_k, V_{2k})
- 10: $v_{k+1} = v_k$
- 11: $V_{k+1} = V_{2k}$
- 12: if $L_k = (V_k - v_k) < \varepsilon$ then
- 13: Stop
- 14: else
- 15: $k = k + 1$
- 16: Go to line 2

K shows the No. 12 of iteration which required to find the voltage at which maximum power will be extracted from the PV panel. Firstly define the interval of uncertainty, v_o normally zero and V_o equal to open circuit voltage of the PV panel than calculated V_{1k} and V_{2k} by the above mention formula of the golden search method. After the calculation of V_{1k} and V_{2k} , calculate power at V_{1k} and V_{2k} and compare these power if $(P(V_{1k}) < P(V_{2k}))$ than maximum power point must be lie in (V_{1k}, V_k) . Now voltage range will be a change from $v_{k+1} = V_{1k}$ and $V_{k+1} = V_k$ otherwise maximum power point must be lie in (v_k, V_{2k}) and voltage range will change from $v_{k+1} = v_k$ and $V_{k+1} = V_{2k}$.

Check the stopping condition, $L_k = (V_k - v_k) < \varepsilon$ if it is true then stop the process otherwise increase the value of k by 1 and repeat the whole process till the finding of the voltage at which maximum power is extracted from the PV panel.

5. SIMULATION RESULT

In this paper, the model is developed with MATLAB/SIMULINK. The proposed model is shown in Fig.-4. The PV module parameter considers for the proposed model are:

V_{OC} (open circuit voltage) =21.8 V.

I_{SC} (short circuit current) =3.11 A.

V_{MP} (voltage at MPP) =17.44.

I_{MP} (current at MPP) =2.86 A.

P_{MP} (power at MPP) =50 W.

The outputs of the PV panel are current and voltage and it depends upon the solar radiance and temperature of the panel. The temperature of PV panel is maintained constant at 25 degree Celsius and solar intensity is varied up to the rated value of 1000 W/m². The current fed to the multiplier to obtain the power in respect to the

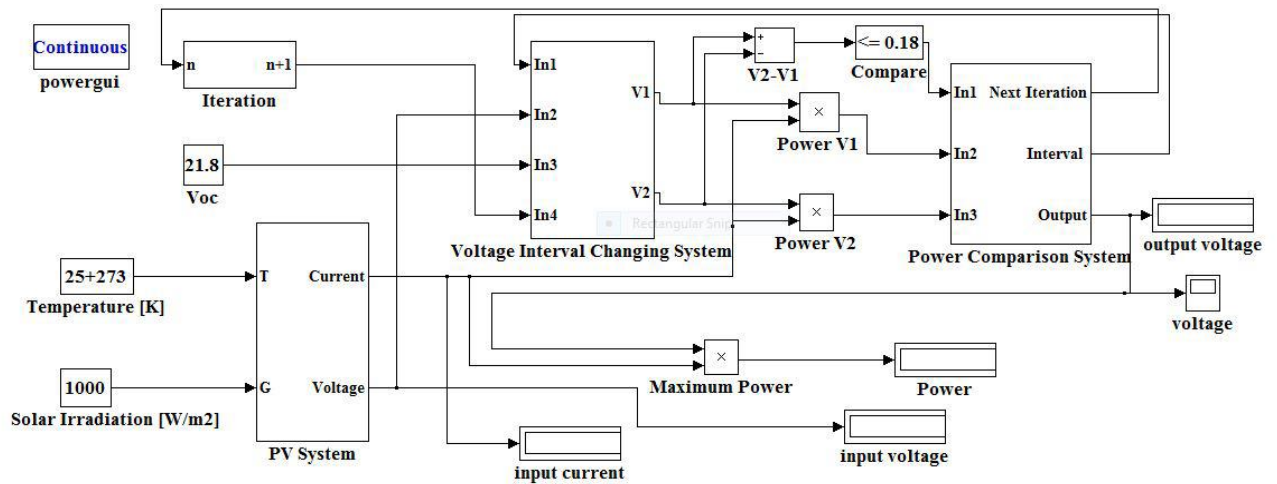

Fig.5 I-V and P-V characteristics of PV Panel

Table 1. Iteration Process Chart.

Iteration	v_o	V_o	V_1	V_2	$P(V_1)$	$P(V_2)$	P^* in interval	$L_K=(V_K-v_K)$
1.	0	21.8	8.33	13.47	25.91	41.76	(8.33,21.8)	21.8
2.	8.33	21.80	13.48	16.65	41.79	49.60	(13.48,21.8)	13.47
3.	13.48	21.80	16.66	18.62	49.61	47.26	(13.48,18.62)	8.32
4.	13.48	18.62	15.44	16.66	47.25	49.61	(15.44,18.62)	5.14
5.	15.44	18.62	16.65	17.41	49.6	50.02	(16.65,18.62)	3.18
6.	16.65	18.62	17.41	17.86	50.02	49.99	(16.65,17.86)	1.97
7.	16.65	17.86	17.11	17.40	49.99	50.02	(17.11,17.86)	1.21
8.	17.11	17.86	17.40	17.57	50.02	49.94	(17.11,17.57)	0.75
9.	17.11	17.57	17.29	17.39	50.03	50.02	(17.11,17.39)	0.46
10.	17.11	17.39	17.21	17.28	50.02	50.03	(17.21,17.39)	0.28
11.	17.21	17.39	17.28	17.32	50.03	50.03	-	018

output voltages of voltage interval changing system and output of PV panel is fed to the voltage interval changing system. V_1 and V_2 voltages are changed in each iteration. Powers are calculated in respect to voltages V_1 and V_2 respectively by the multiplier. Side by side length is compared by tolerance value if its length equal to or less than the tolerance value than iteration is stopped. At voltage, the iteration stop is voltage at which maximum power will be extracted. No. of Iteration requires to finding the maximum power point at different weather condition show in Table 1. No. of iteration is more compare to other methods but the time required in each iteration is very less. Therefore this method has high speed to trace the maximum power point compare to others. The simulation circuit is shown in the Fig-4. In this proposed circuit is without the buck-boost converter, the output voltage level is changed according to the load as well as radiation of sunlight and it is decided or change by Golden Section Search Method. During weather changing condition, the maximum power is not extracted so adjustment of the output voltage is required to extract maximum power. Changing of the load is not in hand because it changes according to demand of consumers. In Fig 5 the various parameter of the proposed method is shown and in Fig-6 and Fig-7 comparison of the proposed method is done with existing methods in all respect. The units of power and length are watts and voltage respectively.

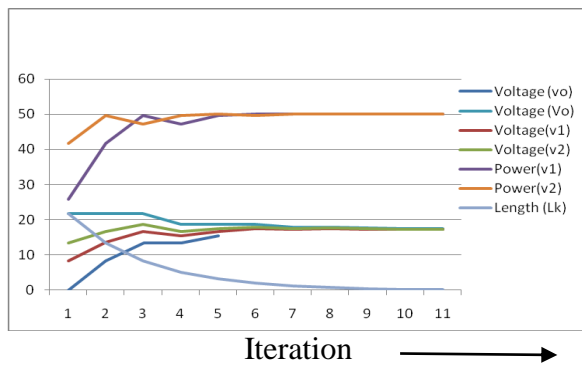

Fig.6 changing of parameters with an iteration of the proposed method.

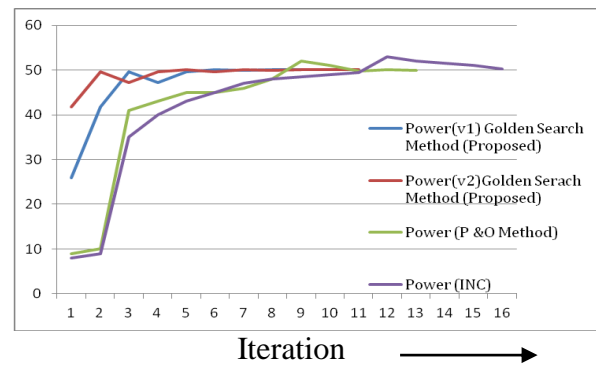

Fig.7 comparisons of the proposed method with others

Table 2. Iteration Process Chart.

MPPT Technique	Classification	Complexity	Tracking Accuracy	Tracking speed	Efficient for partial shading	Application
Voltage-based MPPT	Offline	Simple	Low	Slow	No	Off Grid
Current based MPPT	Offline	Simple	Low	Slow	No	Off Grid
Perturb and Observe	Online	Simple	Medium	Medium	No	Both
INC	Online	Complex	Very High	Fast	Yes	Both
INR	Online	Complex	High	Fast	Yes	Both
RCC	Online	Complex	High	Fast	Yes	Grid
Intelligent based	Hybrid	Complex	Very High	Fast	Yes	Both
Parasitic Capacitance	Online	Complex	Very High	Medium	Yes	Off Grid
Gradient Descent	Hybrid	Medium	High	Medium	No	Off Grid
Golden section Search Method (Proposed)	Hybrid	Simple	Very High	Fast	Yes	Both

6. CONCLUSION

In the present work, the maximum power point tracking is successfully carried out by using a golden search method. Golden search method improves the efficiency and optimized the photovoltaic system without using a buck-boost converter compare to others methods of maximum power point technique. By changing the interval of voltage after each iteration, the length is decreasing by discarding the intervals in where the possibility of obtaining maximum power point is nil. This method is good in respect of accuracy and performance. In this paper, the temperature is removed by making it constant throughout the process by using the heat sink material layer at the back side of the PV panel. The performance is studied by the MATLAB/Simulink. In future, the maximum power point tracking carried out by golden search method without using the buck-boost converter in order to reduce cost, improve response and efficiency, reduce complexity in making and complication of hardware can be removed.

REFERENCES

- [1] Reisi, A. R., Moradi, M. H. & Jamasb, S. (2013.) Classification and comparison of maximum power point tracking techniques for photovoltaic system: A review, *Renewable and Sustainable Energy Reviews*, 19, 433–443.
- [2] Maxwell, J. C. (1881). *A treatise on electricity and magnetism*. Clarendon press.

- [3] Chin, S., Gadson, J., & Nordstrom, K. (2003). Maximum Power Point Tracker. Tufts University Department of Electrical Engineering and Computer Science, 1-66.
- [4] Ahmed, J., & Salam, Z. (2015). An improved perturb and observe (P&O) maximum power point tracking (MPPT) algorithm for higher efficiency. *Applied Energy*, 150, 97-108.
- [5] Subudhi, B., & Pradhan, R. (2013). A comparative study on maximum power point tracking techniques for photovoltaic power systems. *IEEE Transactions on sustainable energy*, 4(1), 89-98.
- [6] Ilyas, A., Ayyub, M., Khan, M. R., Husain, M. A., & Jain, A. (2018). Hardware Implementation of Perturb and Observe Maximum Power Point Tracking Algorithm for Solar Photovoltaic System. *Transactions on Electrical and Electronic Materials*, 19(3), 222-229.
- [7] Husain, M. A., & Tariq, A. (2018). Transient Analysis and Selection of Perturbation Parameter for PV-MPPT Implementation. *International Journal of Ambient Energy*, (just-accepted), 1-8.
- [8] Husain, M. A., Jain, A., & Tariq, A. (2016). A novel fast mutable duty (FMD) MPPT technique for solar PV system with reduced searching area. *Journal of Renewable and Sustainable Energy*, 8(5), 054703.
- [9] Husain, M. A., Khan, A., Tariq, A., Khan, Z. A., & Jain, A. (2018). Aspects Involved in the Modeling of PV System, Comparison of MPPT Schemes, and Study of Different Ambient Conditions Using P&O Method. In *System and Architecture* (pp. 285-303). Springer, Singapore.
- [10] Ilyas, A., Ayyub, M., Khan, M. R., Jain, A., & Husain, M. A. (2017). Realisation of incremental conductance the MPPT algorithm for a solar photovoltaic system. *International Journal of Ambient Energy*, 1-12.
- [11] Agrawal, J., & Aware, M. (2012, December). Golden section search (GSS) algorithm for maximum power point tracking in photovoltaic system. In *Power Electronics (IICPE), 2012 IEEE 5th India International Conference on*, 1-6.
- [12] Ishaque, K., & Salam, Z. (2013), A review of maximum power point tracking techniques of PV system for uniform insolation and partial shading condition, *Renewable and Sustainable Energy Reviews*, (19), 475–488.
- [13] Suresh, K. S., & Prasad, M. V. PV Cell Based Five Level Inverter Using Multicarrier PWM. *International Journal of Modern Engineering Research*, 1(2), 545-551.
- [14] Funde, N., Dhabu, M., Deshpande, P., & Patne, N. R. (2018). SF-OEAP: Starvation-Free Optimal Energy Allocation Policy in a Smart Distributed Multi-Microgrid System. *IEEE Transactions on Industrial Informatics*.
- [15] Husain, M. A., Khan, Z. A., & Tariq, A. (2017). A novel solar PV MPPT scheme utilizing the difference between panel and atmospheric temperature. *Renewable Energy Focus*, 19, 11-22.
- [16] Patrón, R. S. F., Botez, R. M., & Labour, D. (2012). Vertical profile optimization for the Flight Management System CMA-9000 using the golden section search method. In *IECON 2012-38th Annual Conference on IEEE Industrial Electronics Society* (5482-5488).
- [17] Koupaei, J. A., Hosseini, S. M. M., & Ghaini, F. M. (2016). A new optimization algorithm based on chaotic maps and golden section search method. *Engineering Applications of Artificial Intelligence*, 50, 201-214.